

HDMI Signal Extender

VHDI-0060



Features:

- Support HDMI 1.4 / HDCP 1.1&1.2
- Extend transmission distance is up to 60M via Cat.5/6
- Support point-to-point mode
- Pure hardware design, plug and play, do not need to install additional software

The Extender uses single cat-5E or cat-6(recommended) cables instead of HDMI cable to transmit high definition signal up to 60 meters, cutting down the cost. The Extender is designed to supply for long distance transmission of high definition signal.

Specification	VHDI-0060
Model	HDMI Extender
Transmission Distance	Length of CAT-6/CAT-5E cable between Rx and TX Up to 60 meters
HDMI Input	4K/1080p/1080i/720p/576p/576i/480p/480i
HDMI Output	4K/1080p/1080i/720p/576p/576i/480p/480i
Max Bandwidth	340MHz
Max Baud Rate	3x3.4Gbps
Input Video Signal	0.5~1.5 Volts p-p
Output DDC Signal	5Volts p-p (TTL)
Input HDMI Cable Distance	≤ 10m AWG26 HDMI standard cable
Output HDMI Cable Distance	≤ 10m AWG26 HDMI standard cable
TX Max Working Current	350mA
RX Max Working Current	200mA
Power Adapter Format	Input:AC (50HZ, 60HZ) 100V-240V / Output: DC5V/1
Operating Temperature Range	-15°C to +55°C
Operating Humidity Range	5 to 90%RH (No Condensation)
Dimension (L x W x H)	81x43x22 (mm)
Weight	TX Weight: 102g / RX Weight: 103g

Application : point to point application

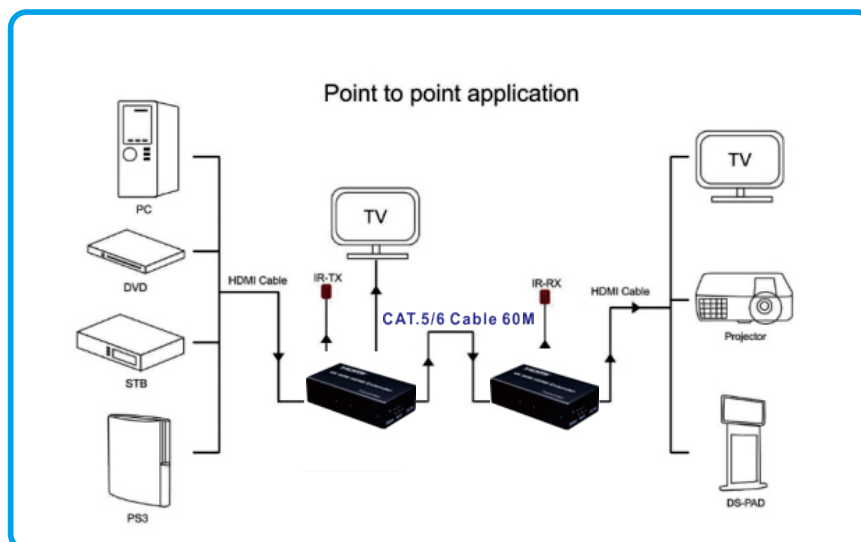

Video Access Technology Corp.

4F.-11, No.6, Lane 609, Sec. 5, Chongxin Rd., Sanchong Dist., New Taipei City, Taiwan (Tong Cheng Industrial Zone)
 Tel:+886-2-2999-8383 Fax:+886-2-2999-0303
 web : www.videoaccess.com

IP Surveillance Equipment
 HD-SDI / 3G-SDI Equipment
 AHD / TVI / CVI Equipment
 HDMI / VGA Equipment
 Speed Dome Camera
 Matrix Switcher Solutions